

The logo features the word "veltex" in a bold, lowercase, sans-serif font with a registered trademark symbol. Below it, the year "2015" is written in a similar font, and "CATALOGO" is written in a smaller, all-caps, sans-serif font. The logo is positioned in the lower right quadrant of the page, set against a white background that is part of a large, stylized circular graphic. This graphic is composed of several overlapping, curved segments in various colors: light green, teal, yellow, magenta, orange, and dark blue. The overall design is modern and vibrant.

veltex[®]
2015
CATALOGO



CELTEX

Loc. il Teso,
Via Traversa del Marginone 21/23
55015 Montecarlo
Lucca - Italy

P. +39 0583 27 41
F. +39 0583 277 777

Info@celtex.it



30 anni di esperienza nella produzione della carta.

“In Celtex da sempre investiamo molto non solo in ricerca e sviluppo ma anche nella costruzione di nuovi stabilimenti e nelle più avanzate tecnologie per la trasformazione. L'azienda, tradizionalmente, pone infatti la massima attenzione ai processi ecosostenibili e al risparmio energetico, alla riduzione dei costi della logistica e alla qualità del customer care che, se uniti alla garanzia di comprare prodotti di alta qualità, sono tra gli elementi cardine per avere successo in questo segmento di mercato.”

Andrea Bernacchi
Amministratore Delegato Celtex SpA

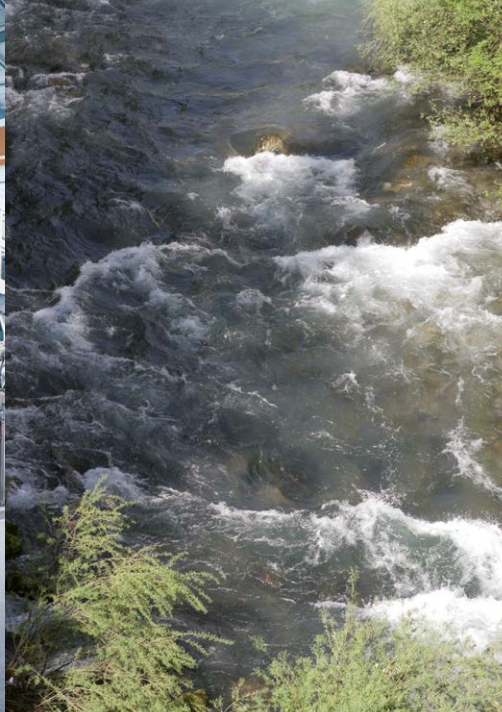



2015. INDUSTRIE CELTEX festeggiano 30 anni di successi.

7 aziende per una filiera dedicata
alla pulizia professionale e al canale Ho.Re.Ca.

È nel cuore della Toscana che batte il cuore pulsante e produttivo delle INDUSTRIE CELTEX, gruppo nato nel 1985. Le cartiere di Pratolungo e di San Lorenzo, e le cinque aziende di converting Celtex, Celtex France, Infibra, Toscofibra e RosaUp, collocano oggi le INDUSTRIE CELTEX tra i leader indiscussi per la produzione di prodotti in tissue dedicati al mondo della pulizia industriale, dell'AFH, dell'RHD, dell'Horeca e del medicale.



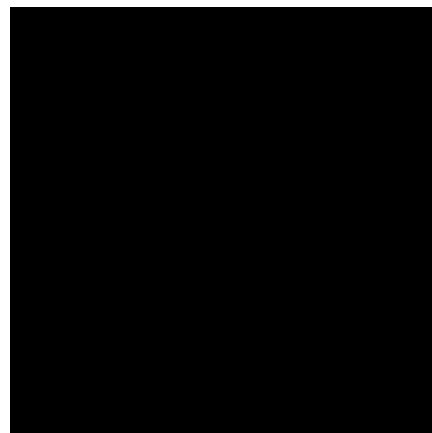



MEGAMINI. DESIGN ITALIANO. **I dispenser esclusivi Celtex.**

La gamma MEGAMINI, nata per rispondere alle più complesse e specifiche esigenze del settore professional, è stata creata come un vero e proprio oggetto d'arredo e di design.

La Celtex, forte della sua trentennale esperienza nel mondo della pulizia e del professional, propone MEGAMINI la nuova e completa famiglia di dispenser a marchio esclusivo Celtex. Funzionalità ed eleganza, solidità e design sono i concetti su cui si è basato lo studio del design esclusivo dei dispenser MEGAMINI. Eliminare dall'oggetto "dispenser" ogni connotazione o forma "sanitaria" per offrire al cliente un arredo funzionale che migliori e potenzi l'eleganza di ogni ambiente bagno, questo il concept da cui è nata MEGAMINI.

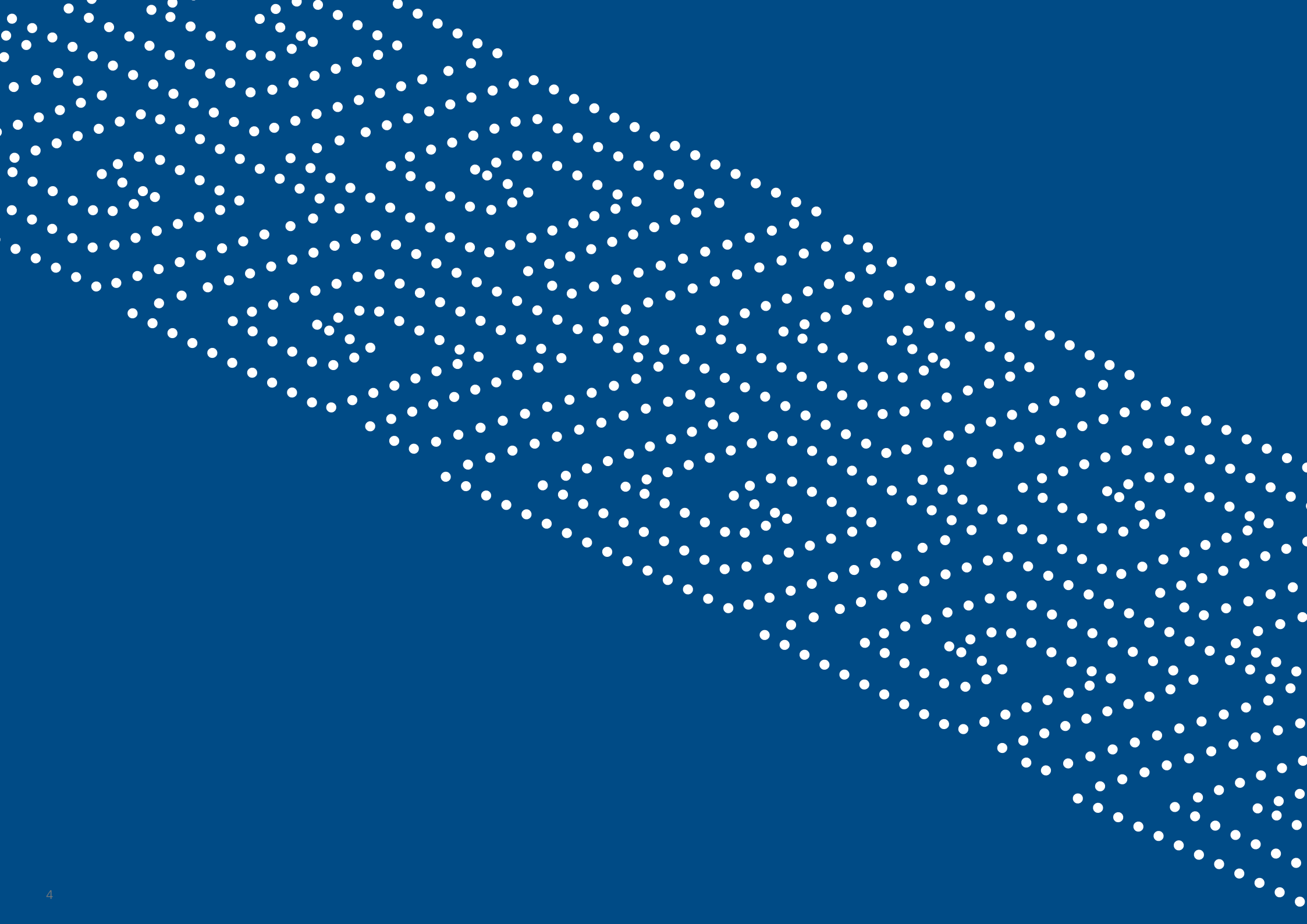

Le goffrature esclusive Celtex

Athena[®], Leonida[®] & Satin[®]

Da anni Celtex è impegnata nello studio di nuove e sempre più efficaci goffrature che valorizzino i prodotti in tissue migliorandone non solo la qualità estetica ma anche l'efficienza e la funzionalità in termini di assorbenza, resistenza e percezione tattile.



LEONIDA[®] E ATHENA[®]. Bellezza e funzionalità

Le goffrature Leonida[®] e Athena[®] richiamano, con i loro nomi, le linee eleganti e simmetriche della classicità e la sobria bellezza dei decori dei pepli dell'antica Grecia. Le due goffrature, utilizzate per gli asciugamani e le carte igieniche interfogliate Celtex, donano al tissue caratteristiche imbattibili di morbidezza e assorbenza e ne migliorano, al contempo la resistenza. Queste caratteristiche garantiscono una maggiore velocità nell'assorbimento dei liquidi e una resa superiore con un notevole risparmio dato dalla riduzione dei consumi.

SATIN[®]. La goffratura che rende il tissue un morbido velluto

Sempre in tema di goffrature, brevettate dalla Celtex, va ricordata anche la goffratura Satin[®]. Prodotta con un nuovo ed esclusivo sistema di lavorazione, consente di dire definitivamente addio ai rotoli industriali eccessivamente rigidi e poco resistenti.

La lavorazione del tissue con un esclusivo sistema di goffrature multiple consente di trattare il prodotto senza agire in modo traumatico sulle fibre mantenendone così intatte tutte le qualità: la resistenza, l'elasticità e la sofficietà.

Satin[®] offre al tatto una eccezionale qualità "tessile", una sensazione incredibilmente soffice, che avvicina i prodotti al vero e proprio tessuto grazie al textile "touch" tipico, di norma, dei prodotti TAD.

LINEA BAGNO

Dimensioni, numero di addetti, utenze giornaliere, modalità di fruizione del servizio, tipologia e categoria delle strutture sono tra gli elementi differenzianti che richiedono, ciascuno, una soluzione professionale mirata e appositamente studiata. Ogni luogo di lavoro infatti richiede prodotti specifici per qualità, tipologia e utilizzo. Celtex, da sempre, è consapevole che dare risposte adeguate e prodotti specifici migliora il comfort e la sicurezza di ciascun ambiente e massimizza la produttività, il risparmio e l'efficienza di ogni azienda.

LINEA BAGNO



LINEA BAGNO

ASCIUGAMANI PIEGATI



INTERFOLD



V FOLD



C FOLD



Z FOLD



Asciugamani Piegati

		Materia prima	Goffratura					Veli	Piega	Dimensioni	Larghezza pacchetto	Unità per conf.	Conf. per collo	Totale pezzi per collo	Colli per pallet
INTERFOGLIATI															
72130	I LUX	100% Cellulosa		X	X	X	X	2		22 cm x 32 cm	11 cm	160	20	3.200	40
73130	I EXCEL	100% Cellulosa		X	X	X	X	3		22 cm x 32 cm	11 cm	125	20	2.500	40
73140	I PLUS EXCEL	100% Cellulosa		X	X	X	X	3		22 cm x 42 cm	11 cm	100	20	2.000	40
PIEGATI A "V"															
72180	V TIME	100% Cellulosa		X	X	X	X	2		21,5 cm x 18 cm	9 cm	195	18	3.510	40
72121	V TREND	100% Cellulosa		X	X	X	X	2		21,5 cm x 22 cm	11 cm	210	15	3.150	40
72122	V CELL	100% Cellulosa		X	X	X	X	2		25 cm x 22 cm	11 cm	210	15	3.150	36
72115	V HYDROSOL	100% Cellulosa		X	X	X	X	3		21,5 cm x 22 cm	11 cm	170	15	2.550	40
72421	V ECO TREND	Cel-75		X	X	X	X	2		21,5 cm x 22 cm	11 cm	210	15	3.150	40
72422	V ECO	Cel-75		X	X	X	X	2		25 cm x 22 cm	11 cm	210	15	3.150	36
72170	E-TISSUE V	E-Tiss		X	X	X	X	2		21,5 cm x 18 cm	9 cm	195	18	3.510	40
PIEGATI A "C"															
70021	C LUX	100% Cellulosa		X	X	X	X	2		23 cm x 32 cm	9 cm	152	20	3.040	40
PIEGATI A "Z"															
72240	Z CELL	100% Cellulosa		X	X	X	X	2		24 cm x 24 cm	8 cm	150	25	3.750	40
72220	Z TREND	100% Cellulosa		X	X	X	X	2		22 cm x 24 cm	8 cm	150	25	3.750	40
72280	MULTI Z LUX	100% Cellulosa		X	X	X	X	2		21,5 cm x 27 cm	9 cm	170	18	3.060	40
73430	MULTI Z EXCEL	100% Cellulosa		X	X	X	X	3		21,5 cm x 27 cm	9 cm	130	18	2.340	40
73440	MULTI M EXCEL	100% Cellulosa		X	X	X	X	3		21,5 cm x 36 cm	9 cm	100	18	1.800	40
72250	MULTI Z BLUE	Cellulosa blu		X	X	X	X	2		21,5 cm x 27 cm	9 cm	170	18	3.060	40
72235	E-TISSUE Z	E-Tiss		X	X	X	X	2		22 cm x 24 cm	8 cm	150	25	3.750	40



MEGAMINI



Cod. 92100
Colore: Nero



Cod. 93100
Colore: Chrome



Cod. 92120
Colore: Bianco



Cod. 92110
Colore: Nero



Cod. 93110
Colore: Chrome



Cod. 92130
Colore: Bianco

Dispenser

		Materia prima	Piega accettata	Codici prodotti ideali per il dispenser	Unità per conf.	Conf. Per collo	Colli per pallet
92100	MEGAMINI ASC. PIEGATI NERO	ABS NERO	V - C - Z - I	72130 - 73130 - 73140 - 72122 - 72121 - 72115 - 72421 - 72422 - 70021 - 72240	1	1	60
92120	MEGAMINI ASC. PIEGATI BIANCO	ABS BIANCO			1	1	60
93100	MEGAMINI ASC. PIEGATI CHROME	ABS CHROME			1	1	60
92110	MEGAMINI M/ZZZ ASC. PIEGATI NERO	ABS NERO	M - Z - V TIME - ZZ	72180 - 72170 - 72220 - 72280 - 73430 - 73440 - 72235 - 72250	1	1	60
92130	MEGAMINI M/ZZZ ASC. PIEGATI BIANCO	ABS BIANCO			1	1	60
93110	MEGAMINI M/ZZZ ASC. PIEGATI CHROME	ABS CHROME			1	1	60

LINEA BAGNO

ASCIUGAMANI IN ROTOLO



Cod. 33103



Cod. 32320



Cod. 32318



Cod. 30270



Cod. 08651



Cod. 32329



Cod. 32312

Rotoli asciugamani ad estrazione interna

		Materia prima	Goffratura					Veli	Ø Rotoli	Ø Anima	Larghezza formato	Lunghezza formato	Lunghezza rotolo	Numero strappi per conf.	Unità per conf.	Conf. per collo	Colli per pallet
33103	MAXIPULL MONO	100% Cellulosa	Micro Embossed	X		X	X	1	20 cm	72s mm	22 cm		320 m	1	1	6	44
32320	SUPERPULL	100% Cellulosa		X	X	X	X	2	20 cm	72s mm	22 cm	38 cm	160 m	421	1	6	44
32318	MAXIPULL SMART	100% Cellulosa		X	X	X	X	2	20 cm	72s mm	20 cm	30 cm	135 m	450	1	6	44
30270	MINIPULL	100% Cellulosa		X	X	X	X	2	13 cm	45s mm	20 cm	34 cm	72 m	212	1	12	55
08651	MANILUX SUPER	100% Cellulosa		X	X	X	X	3	14,2 cm	45s mm	22 cm	24 cm	53 m	220	1	12	40
32329	MAXIPULL TREND BLUE	Cellulosa blu		X		X		2	20 cm	72s mm	20 cm	24 cm	108 m	450	1	6	44
32312	E-TISSUE PULL	E-Tiss		X		X	X	2	20 cm	72s mm	20 cm	24 cm	108 m	450	1	6	44

MEGAMINI



Cod. 92320



Cod. 92300



Cod. 92330



Cod. 92310

Dispenser

		Materia prima	Codici prodotti ideali per il dispenser	Unità per conf.	Conf. per collo	Colli per pallet
92300	MEGAMINI SPIRALE MAXI NERO	ABS NERO	32320 - 32318 - 32312 - 32329 - 33103 - 08660	1	1	39
92320	MEGAMINI SPIRALE MAXI BIANCO	ABS BIANCO		1	1	39
92310	MEGAMINI SPIRALE MINI NERO	ABS NERO	30270 - 08651 - 08650 - 08654 - 08640	1	1	72
92330	MEGAMINI SPIRALE MINI BIANCO	ABS BIANCO		1	1	72



Rotoli asciugamani ad estrazione orizzontale

		Materia prima	Goffratura					Veli	Ø Rotoli	Ø Anima	Larghezza formato	Lunghezza formato	Lunghezza rotolo	Numero strappi per conf.	Unità per conf.	Conf. per collo	Colli per pallet
40404	MANILUX 80	100% Cellulosa		X	X	X	X	2	14,7 cm	39 mm	22 cm	38 cm	80 m	211	1	8	60
40406	MANILUX 50	100% Cellulosa		X	X	X	X	2	13 cm	39 mm	22 cm	38 cm	50 m	132	1	10	50



Cod. 40404



Cod. 40406



Cod. 40107



Cod. 40437



Cod. 40439



Cod. 40300



Cod. 40442



Cod. 40510

Bobine Autocut

		Materia prima	Goffratura					Veli	Ø Rotoli	Ø Anima	Larghezza formato	Lunghezza formato	Lunghezza rotolo	Numero strappi per conf.	Unità per conf.	Conf. per collo	Colli per pallet
40106	MASTER 90	100% Cellulosa		X	X	X	X	3	16 cm	39 mm	20 cm	-	90 m	-	1	6	72
40107	MASTER 120	100% Cellulosa		X	X	X	X	2	16 cm	39 mm	20 cm	-	120 m	-	1	6	72
40437	MASTER 100	100% Cellulosa		X	X	X	X	3	19 cm	39 mm	20 cm	-	100 m	-	1	6	44
40439	MASTER 140	100% Cellulosa		X	X	X	X	2	19 cm	39 mm	20 cm	-	140 m	-	1	6	44
40300	MASTER TIME	100% Cellulosa		X	X	X	X	2	20 cm	39 mm	20 cm	-	285 m	-	1	6	44
40442	BLUE	Cellulosa Blu		X		X		3	19 cm	39 mm	20 cm	-	100 m	-	1	6	44
40510	E-TISSUE MASTER 110	E-Tiss		X		X		2	19 cm	39 mm	20 cm	-	110 m	-	1	6	44

Bobine Autocut / System

		Materia prima	Goffratura				Veli	Ø Rotoli	Ø Anima	Larghezza formato	Lunghezza formato	Lunghezza rotolo	Numero strappi per conf.	Unità per conf.	Conf. per collo	Colli per pallet
41995	CAP SYSTEM PLUS	100% Cellulosa		X	X	X	3	19	dura 39	19 cm	--	95 m	senza strappo	1	6	48
41913	CAP SYSTEM	100% Cellulosa		X	X	X	2	19	dura 39	19 cm	---	130 m	senza strappo	1	6	48
41922	CAP SYSTEM REX	100% Cellulosa		X	X	X	2	20	dura 39	19 cm	---	220 m	senza strappo	1	6	48

LINEA BAGNO

DISTRIBUTORI ASCIUGAMANI IN ROTOLO - CARTE IGIENICHE

Autocut MEGAMINI

Con un nuovo sistema di distribuzione meccanica.



Cod. 92620 | 92630
Colore: Bianco



Cod. 92600 | 92610
Colore: Nero

MASTERMATIC



Cod. 92400
Colore: Nero



Cod. 92420
Colore: Bianco

Dispenser

		Materia prima	Codici prodotti ideali per il dispenser	Unità per conf.	Conf. per collo	Colli per pallet
92600	AUTOCUT NERO	ABS	40106 - 40107 - 40439 - 40437 - 40442 - 40510 - 40300	1	1	54
92620	AUTOCUT BIANCO	ABS		1	1	54
92400	MEGAMINI MASTERMATIC NERO	ABS	40106 - 40107 - 40439 - 40437 - 40442 - 40510 - 40300	1	1	56
92420	MEGAMINI MASTERMATIC BIANCO	ABS		1	1	56



Cod. 22226



Cod. 22223



Cod. 22026



Cod. 22302-76



Cod. 22300

Maxi jumbo

		Materia prima	Goffratura	ISO 9001	ISO 14001	ISO 26000	VELI	Ø Rotoli	Ø Anima	Larghezza o altezza formato	Lunghezza formato	Lunghezza rotolo	Numero strappi per conf.	Conf. per collo	Colli per pallet	
22226-76	MAXI TOILET	Cellulosa		X			X	2	26,5 cm	76 mm	9,2 cm	18 cm	360 m	2.000	6	56
22223	JUMBO	Cellulosa		X			X	2	26,5 cm	76 mm	9,2 cm		320 m	1	6	56
22026	COMFORT MAXI	Cellulosa		X			X	2	26,5 cm	76 mm	9,2 cm	18 cm	260 m	1.445	6	56
22302-76	ECO TOILETTE	T-75		X			X	2	26,5 cm	76 mm	9,2 cm	18 cm	350 m	1.945	6	56
22300	ECO MAXI	T-75		X			X	2	26,5 cm	76 mm	9,2 cm		300 m	1	6	56



Cod. 20160



Cod. 20013



Cod. 20190

Mini jumbo

		Materia prima	Goffratura	ISO 9001	ISO 14001	ISO 26000	VELI	Ø Rotoli	Ø Anima	Larghezza o altezza formato	Lunghezza formato	Lunghezza rotolo	Numero strappi per conf.	Conf. per collo	Colli per pallet	
20160	MINI JUMBO	Cellulosa		X			X	2	19,5 cm	76 mm	9,2 cm		160 m	1	12	52
20013	COMFORT MINI	Cellulosa		X			X	2	18,5 cm	76 mm	9,2 cm	18 cm	130 m	725	12	65
20190	MINI BATH	T-75		X			X	2	19,5 cm	76 mm	9,2 cm		160 m	1	12	52

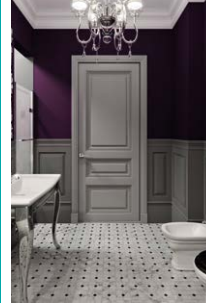

Cod. 71125



Cod. 71300

Igieniche Interfogliate

		Materia prima	Goffratura						Veli	Dimensioni	Numero pezzi per conf.	Conf. Per collo	Pezzi per collo	Colli per pallet
71300	MULTI PACK COMFORT	100% Cellulosa		X				X	2	11 cm x 18 cm	250	36	9.000	40
71125	T PACK COMFORT	100% Cellulosa		X				X	2	11 cm x 21 cm	225	40	9.000	40



Cod. 10060



Cod. 10070



Cod. 10080



Cod. 11200



Cod. 11300



Cod. 10100



Cod. 10670

Igieniche in rotolino domestiche e professionali

		Materia prima	Goffratura				Veli	Ø Rotoli	Ø Anima	Larghezza o altezza formato	Lunghezza formato	Lunghezza rotolo	Numero strappi per conf.	Unità per conf.	Conf. per collo	Colli per pallet
10060	PROFESSIONAL BLUE	100% Cellulosa		X	X	X	2	10,0 cm	45 mm	9,8 cm	11 cm	22 m	200	10	12	21
10070	PROFESSIONAL ORANGE	Cellulosa		X	X	X	2	10,0 cm	45 mm	9,8 cm	11 cm	19 m	170	10	12	21
10080	PROFESSIONAL COMPACT	100% Cellulosa	Punta punta Flowers	X	X	X	2	12,0 cm	45 mm	9,8 cm	11 cm	55 m	500	4	15	22
11200	TISSUE FLOWERS 250	100% Cellulosa	Punta punta Flowers	X	X	X	3	12,0 cm	45 mm	9,8 cm	12 cm	30 m	250	8	9	21
11300	TISSUE FLOWERS PREMIUM "Profumata"	100% Cellulosa	Punta punta Flowers	X	X	X	3	13,0 cm	45 mm	9,8 cm	11 cm	33 m	300	4	6	60
10100	TISSUE FLOWERS HOTEL	100% Cellulosa		X	X	X	2	11,0 cm	45 mm	9,8 cm	11 cm	20 m	180	4	24	24
10670	INFINITY PROF	100% Cellulosa		X	X	X	2	12,8 cm	45 mm	9,5 cm	11 cm	74 m	670	3	9	48

LINEA BAGNO

DISPENSER

MEGAMINI



Cod. 92200



Cod. 92230



Cod. 93260

Dispenser

Dispenser		Materia prima	Codici prodotti ideali per il dispenser	Unità per conf.	Conf. Per collo	Colli per pallet
91016	DISPENSER PER ROTOLO PICCOLO DUO	ABS	10060 - 10070 - 10080 - 11200 - 11300 - 10100 - 10670	1	1	180
92200	MEGAMINI MAXI JUMBO NERO	ABS NERO	22226-76 - 22223 - 22026 - 22302-76 - 22300	1	1	63
92220	MEGAMINI MAXI JUMBO BIANCO	ABS BIANCO		1	1	63
93200	MEGAMINI MAXI JUMBO CHROME	ABS CHROME		1	1	63
91001	JUMBO MAXI	ACCIAIO BIANCO	22226-76 - 22223 - 22026 - 22302-76 - 22300	1	1	138
92210	MEGAMINI MINI JUMBO NERO	ABS NERO	20160 - 20190 - 20013	1	1	81
92230	MEGAMINI MINI JUMBO BIANCO	ABS BIANCO		1	1	81
93210	MEGAMINI MINI JUMBO CHROME	ABS CHROME		1	1	81
92260	MEGAMINI IGIENICA INTERFOGLIATA NERO	ABS NERO	71300 - 71125	1	1	135
92270	MEGAMINI IGIENICA INTERFOGLIATA BIANCO	ABS BIANCO		1	1	135
93260	MEGAMINI IGIENICA INTERFOGLIATA CHROME	ABS CHROME		1	1	135



Cod. 91700



Cod. 91720

Cestino gettacarta

Cestino gettacarta		Materia prima	Unità per conf.	Conf. per collo	Colli per pallet
91700	CESTINO GETTACARTA NERO	ABS NERO	1	2	38
91720	CESTINO GETTACARTA BIANCO	ABS BIANCO	1	2	38



LINEA ESTETICA E MEDICALE

Da anni la qualità Celtex è innanzi tutto garantita dalle particolari caratteristiche tecniche con cui è lavorato il tissue. L'adozione della goffratura Satin®, come dimostrato dai test effettuati, migliora fortemente la capacità di assorbenza, la resistenza e la robustezza del tissue e, cosa altrettanto importante, lo rende impeccabile dal primo all'ultimo strappo.

Celtex, per offrire il massimo della protezione e dell'igiene nei rotoli da lettino li confeziona uno ad uno con un packaging studiato per essere massimamente protettivo e minimamente inquinante in termini ambientali: un leggerissimo e resistente velo di polietilene avvolge ogni singolo rotolo proteggendolo fino al momento del suo utilizzo.

Per scelta di tipologie, misure e qualità di tissue la gamma Celtex è imbattibile: per ogni lettino e ambiente di lavoro in Celtex si può trovare il rotolo che corrisponde perfettamente alle esigenze dell'operatore e della sua clientela.

LINEA ESTETICA E MEDICALE

Celtex, si colloca all'avanguardia in questo delicato segmento del Professional grazie ai prodotti attentamente profilati secondo le più specifiche esigenze del medicale, del sanitario, dell'estetica e del fitness.



LINEA ESTETICA E MEDICALE



Cod. 62607



Cod. 62657



Cod. 62609



Cod. 64616



Cod. 60205

Lenzuolini medici

		Materia prima	Goffratura	CE	ISO 9001	ISO 13485	ISO 14001	ISO 15189	vel	Ø Rotoli	Ø Anima	Larghezza formato	Lunghezza formato	Lunghezza rotolo	Numero strappi per conf.	Unità per conf.	Conf. per collo	Colli per pallet
62607	MEDILUX	100% Cellulosa		X	X	X	X	X	2	14,7 cm	39 mm	60 cm	38 cm	80 m	211	1	6	32
62657	MEDILUX SIX	100% Cellulosa		X	X	X	X	X	2	13 cm	39 mm	60 cm	38 cm	50 m	132	1	9	24
62609	MEDILUX KING	100% Cellulosa		X	X	X	X	X	2	14,7 cm	39 mm	84 cm	38 cm	80 m	211	1	4	24
62604	SOLARIUM	100% Cellulosa		X	X	X	X	X	2	14,7 cm	39 mm	46 cm	38 cm	80 m	211	1	6	40
64817	STANDARD	Cel-75		X	X		X	X	1	13 cm	39 mm	60 cm	38 cm	90 m	236	1	9	24
64616	MEDIMIX	Cel-75		X	X		X	X	2	14,7 cm	39 mm	55 cm	38 cm	80m	211	1	6	32
60205	POLYLUX SIX	100% Cell.+PE		X					2	10 cm	39 mm	60 cm	38 cm	50 m	132	1	9	24



Distributore

		Materiale	Codici di prodotti ideali per il dispenser	Unità per conf.	Conf. Per collo	Colli per pallet
91993	LETTINO VISITA	Metallo Cromato	62607 - 62657 - 62609 - 62604 - 64817 - 64616 - 60205	1	4	250



Cod. 81100

Cod. 81200

Bavaglio monouso

		Materia prima	Veli	Dimensione formato	Unità per conf.	Conf. per collo	Colli per pallet
81100	PIEGATO CON DISPENSER	100% Cell.+PE	2	48 cm x 58 cm	200	3	35
81200	STESO	100% Cell.+PE	2	48 cm x 58 cm	250	4	18



Veline

		Materia prima	Goffratura				Veli	Dimensione formato	Unità per conf.	Conf. per collo	Colli per pallet
08900	VELINE COSMETICHE	100% Cellulosa	Liscia	X	X	X	2	21 cm x 20 cm	100	40	36

LINEA INDUSTRIA

Il catalogo di prodotti per l'industria offre una infinita varietà di formati e soluzioni, come le tipologie di rotoli industriali.

I prodotti Celtex per l'industria sono i migliori partner per ottimizzare i processi di lavorazione ed esecuzione di compiti specifici.

LINEA INDUSTRIA



eltex[®]

LINEA INDUSTRIA

ROTOLI ASCIUGAMANI AD ESTRAZIONE INTERNA - ROTOLI ASCIUGATUTTO



Cod. 33103



Cod. 32320



Cod. 32318



Cod. 30270



Cod. 08651



Cod. 32329



Cod. 32312

Rotoli asciugamani ad estrazione interna

		Materia prima	Goffratura					Veli	Ø Rotoli	Ø Anima	Larghezza formato	Lunghezza formato	Lunghezza rotolo	Numero strappi per conf.	Unità per conf.	Conf. per collo	Colli per pallet
33103	MAXIPULL MONO	100% Cellulosa	Micro Embossed	X			X	1	20 cm	72s mm	22 cm		320 m	1	1	6	44
32320	SUPERPULL	100% Cellulosa		X	X	X	X	2	20 cm	72s mm	22 cm	38 cm	160 m	421	1	6	44
32318	MAXIPULL SMART	100% Cellulosa		X	X	X	X	2	20 cm	72s mm	20 cm	30 cm	135 m	450	1	6	44
30270	MINIPULL	100% Cellulosa		X	X	X	X	2	13 cm	45s mm	20 cm	34 cm	72 m	212	1	12	55
08651	MANILUX SUPER	100% Cellulosa		X	X	X	X	3	14,2 cm	45s mm	22 cm	24 cm	53 m	220	1	12	40
32329	MAXIPULL TREND BLUE	Cellulosa blu		X			X	2	20 cm	72s mm	20 cm	24 cm	108 m	450	1	6	44
32312	E-TISSUE PULL	E-Tiss		X			X	2	20 cm	72s mm	20 cm	24 cm	108 m	450	1	6	44

MEGAMINI



Cod. 92320



Cod. 92300



Cod. 92330



Cod. 92310

Dispenser

		Materia prima	Codici prodotti ideali per il dispenser	Unità per conf.	Conf. per collo	Colli per pallet
92300	MEGAMINI SPIRALE MAXI NERO	ABS NERO	32320 - 32318 - 32312 - 32329 - 33103 - 08660	1	1	39
92320	MEGAMINI SPIRALE MAXI BIANCO	ABS BIANCO		1	1	39
92310	MEGAMINI SPIRALE MINI NERO	ABS NERO	30270 - 08651 - 08650 - 08654 - 08640	1	1	72
92330	MEGAMINI SPIRALE MINI BIANCO	ABS BIANCO		1	1	72



Rotoli Asciugatutto

		Materia prima	Goffratura					Veli	Ø Rotoli	Ø Anima	Larghezza formato	Lunghezza formato	Lunghezza rotolo	Numero strappi per conf.	Unità per conf.	Conf. per collo	Colli per pallet
08660	ISOTTA	100% Cellulosa		X	X	X	X	2	20 cm	45s mm	22 cm	20 cm	100 m	500	1	6	44
08650	TRITONE	100% Cellulosa		X	X	X	X	3	14,2 cm	45s mm	22 cm	24 cm	53 m	220	1	12	40
08654	TITANO	100% Cellulosa		X	X	X	X	2	14,2 cm	45s mm	22 cm	24 cm	66 m	275	1	12	40
08640	E-TISSUE CLEAN	E-Tiss		X		X	X	2	14,2 cm	45s mm	22 cm	25 cm	50 m	200	1	12	40

LINEA INDUSTRIA

ROTLI INDUSTRIALI



Cod. 36800



Cod. 53800



Cod. 53150



Cod. 36464



Cod. 52502



Cod. 52504



Cod. 52506



Cod. 57576



Cod. 58578



Cod. 52528



Cod. 54010



Cod. 54550



Cod. 52522



Cod. 35112



Cod. 59615



Cod. 59618



Cod. 54541



Cod. 54544



Cod. 54600



Cod. 58582

Rotoli Industriali

		Materia prima	Goffratura						Veli	Ø Rotoli	Ø Anima	Larghezza o altezza formato	Lunghezza formato	Lunghezza rotolo	Numero strappi per conf.	Unità per conf.	Conf. per collo	Colli per pallet
36800	EASY WIPE	100% Cellulosa		X	X	X	X	X	2	25 cm	72 mm	24 cm	22 cm	176 m	800	-	2	70
53800	800 PERFORMANCE	100% Cellulosa		X	X	X	X	X	2	30 cm	72 mm	26,5 cm	30 cm	240 m	800	-	2	54
53150	1500 PERFORMANCE	100% Cellulosa		X	X	X	X	X	2	39 cm	72 mm	26,5 cm	30 cm	450 m	1.500	-	2	27
36464	SMART	100% Cellulosa		X	X	X	X	X	2	25 cm	72s mm	24 cm	30 cm	240 m	800	-	2	70
52502	TREND	100% Cellulosa		X	X	X	X	X	2	28 cm	72s mm	26,5 cm	34 cm	272 m	800	-	2	54
52504	LUX 800	100% Cellulosa		X	X	X	X	X	2	29 cm	72 mm	26,5 cm	38 cm	304 m	800	-	2	54
52506	LUX 1500	100% Cellulosa		X	X	X	X	X	2	39 cm	72 mm	26,5 cm	38 cm	570 m	1.500	-	2	27
57576	SUPERLUX 500	100% Cellulosa		X	X	X	X	X	3	28 cm	72 mm	26,5 cm	38 cm	190 m	500	-	2	54
58578	SUPERLUX 1000	100% Cellulosa		X	X	X	X	X	3	39 cm	72 mm	26,5 cm	38 cm	380 m	1.000	-	2	27
52528	CLASSIC 800	100% Cellulosa	Liscia	X		X	X	X	2	28 cm	72 mm	26,5 cm	38 cm	304 m	800	-	2	54
52522	CLASSIC 2000	100% Cellulosa	Liscia	X		X	X	X	2	39 cm	72 mm	26,5 cm	38 cm	760 m	2.000	-	1	54
54010	TENDER	Cel-75		X		X	X	X	2	24 cm	72 mm	24 cm	22 cm	176 m	800	-	2	90
54550	ECOWIPER	Cel-75		X		X	X	X	2	29 cm	72 mm	26,5 cm	30 cm	240 m	800	-	2	54
35112	BLUE WIPER	Cellulosa blu		X		X			2	28 cm	72s mm	24 cm	30 cm	290 m	970	-	2	60
59615	SUPERBLUE FOOD	Cellulosa blu		X		X			3	28 cm	72 mm	26,5 cm	30 cm	150 m	500	-	2	54
59618	SUPERBLUE 500	Cellulosa blu		X		X			3	30 cm	72 mm	36 cm	36 cm	180 m	500	-	2	36
54541	E-TISSUE L	E-Tiss		X		X	X	X	2	28 cm	72s mm	24 cm	30 cm	240 m	800	-	2	60
54544	E-TISSUE SMART	E-Tiss		X		X	X	X	2	28 cm	72s mm	26,5 cm	30 cm	240 m	800	-	2	54
54600	E-TISSUE XL	E-Tiss		X		X	X	X	2	33 cm	72s mm	24 cm	30 cm	360 m	1.200	-	2	40
58582	E-TISSUE 500	E-Tiss		X		X	X	X	3	28 cm	72s mm	26,5 cm	38 cm	190 m	500	-	2	54



Top Wiper

		Materia prima	Goffratura					Veli	Ø Rotoli	Ø Anima	Larghezza o altezza formato	Lunghezza formato	Lunghezza rotolo	Numero strappi per conf.	Unità per conf.	Conf. per collo	Colli per pallet
85350	TOP 350	TNT - BIANCO	Liscia			X	X	1	27 cm	72 mm	26 cm	34 cm	119 m	350	1	2	54



Panni Antistatici

		Materia prima	Goffratura					Veli	Dimensioni	Unità per conf.	Conf. per collo	Totale pezzi per collo	Colli per pallet
86022	LINTEX 22 - UMIDO	TNT DEPOLVERANTE	no					1	22 cm x 60 cm	100	10	1.000	32



Dispenser per rotoli industriali

		Materia prima	Codici prodotti ideali per il dispenser	Unità per conf.	Conf. per collo	Colli per pallet
91560	DISPENSER A MURO	ACCIAIO VERNICIATO	UNIVERSALE	1	1	70
91550	DISPENSER A TERRA	ACCIAIO VERNICIATO		1	1	70
91536	DISPENSER CARENATO	ABS	36800 - 36464 - 52502 - 52528 - 57576 - 35112 - 59615 - 54010 - 54550 - 54541 - 54544 - 58582 - 85350	1	1	36

LINEA HORECA

Hotel, bar, ristoranti hanno esigenze di igiene e pulizia altamente specializzate e diversificate. Dimensioni, numero di addetti, utenze giornaliere, modalità di fruizione del servizio, tipologia e categoria delle strutture stesse sono tra gli elementi differenzianti che richiedono, ciascuno, una soluzione professionale mirata e appositamente studiata.

Obiettivo principale di Celtex è mantenere l'igiene, la pulizia e l'ordine in tutti gli ambienti della struttura dalle cucine ai bagni, dalle sale comuni alle camere, dalla reception al bar.

Un ambiente pulito, ordinato e igienicamente garantito, assieme comfort del servizio, sono determinanti per la clientela di ogni attività del mondo Ho.Re.Ca..

LINEA HORECA

Celtex si propone al mondo dell'Ho.Re.Ca.
con una gamma completa di prodotti per la pulizia e l'igiene.







celtex

Tissue Flowers



Igieniche Tissue Flowers

		Materia prima	Goffratura					Veli	Ø Rotoli	Ø Anima	Numero strappi per conf.	Colli per pallet
11200	TISSUE FLOWERS 250	100% Cellulosa	Punta punta Flowers	X			X	3	9	8	250	21
11300	TISSUE FLOWERS PREMIUM "Profumata"	100% Cellulosa	Punta punta Flowers	X			X	3	6	4	300	60
10100	TISSUE FLOWERS HOTEL	100% Cellulosa		X			X	2	24	4	180	24



Veline Tissue Flowers

		Materia prima	Goffratura				Veli	Dimensione formato	Unità per conf.	Conf. per collo	Colli per pallet
08900	VELINE COSMETICHE	100% Cellulosa	Liscia	X	X	X	2	21 cm x 20 cm	100	40	36



**COLLECTION
TISSUE FLOWERS.**

**ELEGANZA RAFFINATA E
ALTA QUALITÀ IN OGNI
AMBIENTE BAGNO.**

Tissue Flowers

Tissue Flowers

IL ROTOLO IGIENICO VESTE L'ANIMA
E DIVENTA UN COMPLEMENTO DI ARREDO.







LINEA HORECA

TOVAGLIOLI



Tovaglioli











		Materia Prima	Goffratura					Veli	Dimensioni	Numero Pezzi Per Conf.	Conf. Per Collo	Pezzi Per Collo	Colli Per Pallet
08030	MONO 30	100% Cellulosa	Microgoffrato	X	X	X		1	30 cm x 30 cm	200	24	4.800	17
08233	CAPALBIO PROFESSIONAL	100% Cellulosa	Capalbio incollato a Decoro	X	X	X		2	33 cm x 33 cm	50	36	1.800	24
08238	CAPALBIO PROFESSIONAL	100% Cellulosa	Capalbio incollato a Decoro	X	X	X		2	38 cm x 38 cm	50	36	1.800	24
08440	CAPALBIO	100% Cellulosa	Capalbio incollato a Decoro	X	X	X		4	40 cm x 40 cm	50	24	1.200	20

LINEA HORECA

ROTOLI ASCIUGATUTTO



Rotoli Asciugatutto

		Materia prima	Goffratura					Veli	Ø Rotoli	Ø Anima	Larghezza formato	Lunghezza formato	Lunghezza rotolo	Numero strappi per conf.	Unità per conf.	Conf. per collo	Colli per pallet
08660	ISOTTA 	100% Cellulosa		X	X	X	X	2	20 cm	45s mm	22 cm	20 cm	100 m	500	1	6	44
08650	TRITONE	100% Cellulosa		X	X	X	X	3	14,2 cm	45s mm	22 cm	24 cm	53 m	220	1	12	40
08654	TITANO 	100% Cellulosa		X	X	X	X	2	14,2 cm	45s mm	22 cm	24 cm	66 m	275	1	12	40
08640	E-TISSUE CLEAN 	E-Tiss		X		X	X	2	14,2 cm	45s mm	22 cm	25 cm	50 m	200	1	12	40

LINEA E-TISSUE

La linea E-Tissue soddisfa tutti parametri necessari, dall'alimentarietà al marchio Ecolabel nel rispetto delle più rigorose normative a tutela del consumatore e dell'ambiente. Il tissue riciclato di questi prodotti è straordinario per quanto riguarda le caratteristiche di resistenza, assorbenza e sensazione al tatto di morbidezza. Tutto questo in un prodotto che si propone oggi sul mercato con rapporto qualità prezzo davvero conveniente dove il costo servizio di un prodotto E-Tissue è pari ad un riciclato di vecchia concezione ma offre prestazioni pari ad un'ottima pura cellulosa.

LINEA E-TISSUE

E-Tissue, la gamma di prodotti in carta riciclata dedicata al mercato Professional.



veltex

LINEA E-TISSUE

LINEA BAGNO - INDUSTRIALE - HORECA

Rotoli asciugamani senza pretaglio



		Materia prima	Goffratura					Veli	Ø Rotoli	Ø Anima	Larghezza formato	Lunghezza formato	Lunghezza rotolo	Numero strappi per conf.	Unità per conf.	Conf. per collo	Colli per pallet
40510	E-TISSUE MASTER 110	E-Tiss		X		X	X	2	19 cm	39 mm	20 cm	110 m			1	6	44

Asciugamani piegati



		Materia prima	Goffratura					Veli	Piegatura	Dimensioni	Larghezza pacchetto	Unità per conf.	Conf. per collo	Totale pezzi per collo	Colli per pallet
PIEGATI A "V"															
72170	E-TISSUE V	E-Tiss		X		X	X	2		21,5 cm x 18 cm	9 cm	195	18	3.510	40
PIEGATI A "Z"															
72235	E-TISSUE Z	E-TISSUE		X		X	X	2		22 cm x 24 cm	8 cm	150	25	3.750	40



Cod. 92110 Colore: Nero
 Cod. 93110 Colore: Chrome
 Cod. 92130 Colore: Bianco

Dispenser

		Materia prima	Piegatura accettata	Codici prodotti ideali per il dispenser	Unità per conf.	Conf. Per collo	Colli per pallet
92110	MEGAMINI M/Z/ZZ ASC. PIEGATI NERO	ABS NERO	M - Z - V TIME - ZZ	72235	1	1	60
92130	MEGAMINI M/Z/ZZ ASC. PIEGATI BIANCO	ABS BIANCO			1	1	60
93110	MEGAMINI M/Z/ZZ ASC. PIEGATI CHROME	ABS CHROME			1	1	60



Cod. 54541



Cod. 54544



Cod. 54600



Cod. 58582

Rotoli Industriali

Rotoli Industriali		Materia prima	Goffratura	FSC	SEPC	Recycling	Vel	Ø Rotoli	Ø Anima	Larghezza formato	Lunghezza formato	Lunghezza rotolo	Numero strappi per conf.	Conf. per collo	Colli per pallet
54541	E-TISSUE L	E-Tiss		X		X	2	28 cm	72s mm	24 cm	30 cm	240 m	800	2	60
54544	E-TISSUE SMART	E-Tiss		X		X	2	28 cm	72s mm	26,5 cm	30 cm	240 m	800	2	54
54600	E-TISSUE XL	E-Tiss		X		X	2	33 cm	72s mm	24 cm	30 cm	360 m	1.200	2	40
58582	E-TISSUE 500	E-Tiss		X		X	3	28 cm	72s mm	26,5 cm	38 cm	190 m	500	2	54

Rotoli Asciugamano ad estrazione interna

Rotoli Asciugamano ad estrazione interna		Materia prima	Goffratura	FSC	SEPC	Recycling	Vel	Ø Rotoli	Ø Anima	Larghezza formato	Lunghezza formato	Lunghezza rotolo	Numero strappi per conf.	Unità per conf.	Conf. per collo	Colli per pallet
08640	E-TISSUE CLEAN	E-Tiss		X		X	2	14,2 cm	45s mm	22 cm	25 cm	50 m	200	1	12	40
32312	E-TISSUE PULL	E-Tiss		X		X	2	20 cm	72s mm	20 cm	24 cm	108 m	450	1	6	44



MEGAMINI



Cod. 92320



Cod. 92300



Cod. 92330



Cod. 92310

Dispenser

Dispenser		Materia prima	Codici prodotti ideali per il dispenser	Unità per conf.	Conf. per collo	Colli per pallet
92300	MEGAMINI SPIRALE MAXI NERO	ABS NERO	32312	1	1	39
92320	MEGAMINI SPIRALE MAXI BIANCO	ABS BIANCO		1	1	39
92310	MEGAMINI SPIRALE MINI NERO	ABS NERO	08640	1	1	72
92330	MEGAMINI SPIRALE MINI BIANCO	ABS BIANCO		1	1	72



UBIMAIOR

La linea di dispenser Ubi Maior trova la sua naturale collocazione nei luxury hotel, nei locali da bagno di prestigiosi ristoranti e in raffinate abitazioni private. Questi luoghi esclusivi sono infatti cornice perfetta per la serie di complementi d'arredo della linea Ubi Maior.



UBIMAIOR

Il marmo e l'acciaio inossidabile, materiali preziosi ed esclusivi, danno vita ad oggetti d'uso quotidiano dalle eleganti linee neoclassiche.



eltex®



PORTAROTOLO ASCIUGATUTTO

Cod. 92900
 Marmo bianco di Carrara
 Acciaio inox
 H. 31,5 cm
 L. x P. 18 x 18 cm



PORTAROTOLO ASCIUGATUTTO

Cod. 92901
 Marmo nero di Spagna
 Acciaio inox
 H. 31,5 cm
 L. x P. 18 x 18 cm



PORTASCIUGAMANI PIEGATI O VELINE

Cod. 92910
 Marmo bianco di Carrara
 H. 10 cm
 L. x P. 25,5 x 14 cm



PORTASCIUGAMANI PIEGATI O VELINE

Cod. 92911
 Marmo nero di Spagna
 H. 10 cm
 L. x P. 25,5 x 14 cm



PORTAROTOLO CARTA IGIENICA A PAVIMENTO

Cod. 92920
 Marmo bianco di Carrara
 Acciaio inox
 H. 62,5 cm
 L. x P. 15 x 15 cm



PORTAROTOLO CARTA IGIENICA A PAVIMENTO

Cod. 92921
 Marmo nero di Spagna
 Acciaio inox
 H. 62,5 cm
 L. x P. 15 x 15 cm

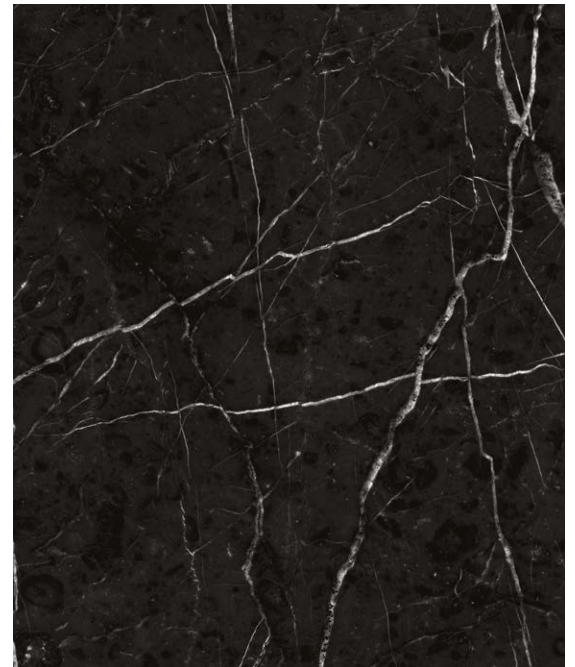

MEGAMINI. DESIGN ITALIANO.

MEGAMINI si presenta sul mercato internazionale come una linea completa di oggetti d'arredo che risponde in pieno non solo alle più complesse esigenze del bagno in termini di funzionalità, igiene, risparmio e resistenza ma garantisce, al contempo, la qualità estetica e l'eleganza di ogni ambiente bagno dove venga installata.

MEGAMINI.DESIGN ITALIANO.

Quando design ed eleganza garantiscono pulizia e massima igiene in ogni bagno.



celtex®

MINI JUMBO



Cod. 92210
Colore: Nero



Cod. 93210
Colore: Chrome



Cod. 92230
Colore: Bianco

Scheda Tecnica

Dim. imballo:
L= 250 mm P= 125 mm H= 315 mm
Tipo imballo: scatola cartone
Peso Lordo: gr 1050
Pezzi per collo: 1
Volume imballo: 9,8 dm³
Colli per pallet: 81

Articoli Associati

- 20160
- 20013
- 20190

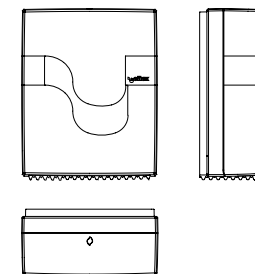

Materiale: plastica
Dimensioni: L= 235 mm P=115 mm H=295 mm
Peso netto: gr 900

MAXI JUMBO



Cod. 92200
Colore: Nero



Cod. 93200
Colore: Chrome



Cod. 92220
Colore: Bianco

Scheda Tecnica

Dim. imballo:
L= 330 mm P= 130 mm H= 395 mm
Tipo imballo: scatola cartone
Peso Lordo: gr 1600
Pezzi per collo: 1
Volume imballo: 17 dm³
Colli per pallet: 63

Articoli Associati

- 22226 - 76
- 22223
- 22026
- 22302 - 76
- 22300

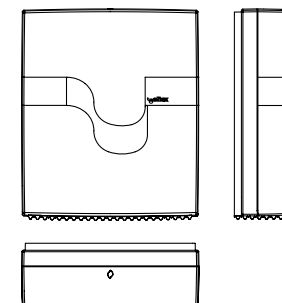

Materiale: plastica
Dimensioni: L= 315 mm P=115 mm H=375 mm
Peso netto: gr 1350

IGIENICA INTERFOGLIATA



Cod. 92260
Colore: Nero



Cod. 93260
Colore: Chrome



Cod. 92270
Colore: Bianco

Scheda Tecnica

Dim. imballo:
L= 150 mm P= 125 mm H= 340 mm
Tipo imballo: scatola cartone
Peso Lordo: gr 750
Pezzi per collo: 1
Volume imballo: 6,4 dm³
Colli per pallet: 135

Articoli Associati

- 71300
- 71125

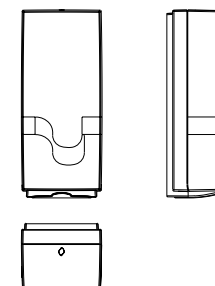

Materiale: plastica
Dimensioni: L= 135 mm P=110 mm H=320 mm
Peso netto: gr 600

ASCIUGAMANI PIEGATI



Cod. 92100
Colore: Nero



Cod. 93100
Colore: Chrome



Cod. 92120
Colore: Bianco

Scheda Tecnica

Dim. imballo:
L= 290 mm P= 140 mm H= 375 mm
Tipo imballo: scatola cartone
Peso Lordo: gr 1450
Pezzi per collo: 1
Volume imballo: 15,3 dm3
Colli per pallet: 60

Articoli Associati

- 72130 • 72421
- 73130 • 72422
- 73140 • 72115
- 72121 • 70021
- 72122 • 72240

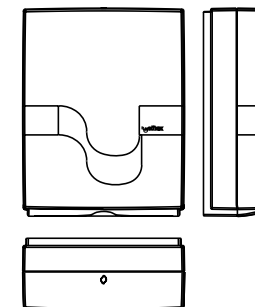

Materiale: plastica
Dimensioni: L= 275 mm P=125 mm H=360 mm
Peso netto: gr 1200

M / Z / ZZ ASCIUGAMANI PIEGATI



Cod. 92110
Colore: Nero



Cod. 93110
Colore: Chrome



Cod. 92130
Colore: Bianco

Scheda Tecnica

Dim. imballo:
L= 265 mm P= 125 mm H= 375 mm
Tipo imballo: scatola cartone
Peso Lordo: gr 1150
Pezzi per collo: 1
Volume imballo: 12,4 dm3
Colli per pallet: 81

Articoli Associati

- 72280 • 72180
- 72250 • 72170
- 73430 • 72220
- 73440 • 72235

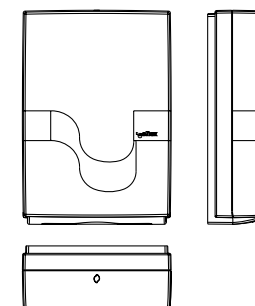

Materiale: plastica
Dimensioni: L= 245 mm P=105 mm H=360 mm
Peso netto: gr 1000

SPIRALE MAXI



Cod. 92320
Colore: Bianco



Cod. 92300
Colore: Nero

Scheda Tecnica

Dim. imballo:
L= 250 mm P= 245 mm H= 370 mm
Tipo imballo: scatola cartone
Peso Lordo: gr 1650
Pezzi per collo: 1
Volume imballo: 22,7 dm³
Colli per pallet: 39

Articoli Associati

- 32320 • 32329
- 32318 • 33103
- 32312 • 08660

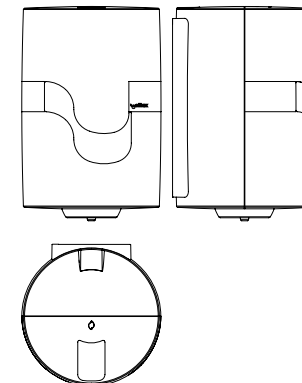

Materiale: plastica
Dimensioni: L= 225 mm P=230 mm H=350 mm
Peso netto: gr 1450

SPIRALE MINI



Cod. 92330
Colore: Bianco



Cod. 92310
Colore: Nero

Scheda Tecnica

Dim. imballo:
L= 185 mm P=180 mm H= 355 mm
Tipo imballo: scatola cartone
Peso Lordo: gr 1150
Pezzi per collo: 1
Volume imballo: 11,8 dm³
Colli per pallet: 72

Articoli Associati

- 30270 • 08654
- 08651 • 08640
- 08650

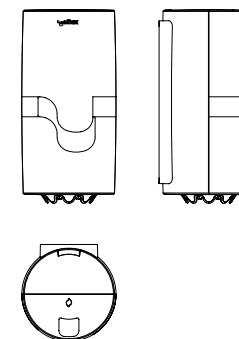

Materiale: plastica
Dimensioni: L= 160 mm P=170 mm H=345 mm
Peso netto: gr 900

MASTERMATIC DISPENSER ROTOLI ASCIUGAMANI SENZA PRETAGLIO



Cod. 92400
Colore: Nero



Cod. 92420
Colore: Bianco

Scheda Tecnica

Dim. imballo:
L= 315 mm P= 240 mm H= 450 mm
Tipo imballo: scatola cartone
Peso Lordo: gr 4.500
Pezzi per collo: 1
Volume imballo: 34,0 dm³
Colli per pallet: 56

Articoli Associati

- 40510
- 40300
- 40439
- 40106
- 40437
- 40107
- 40442

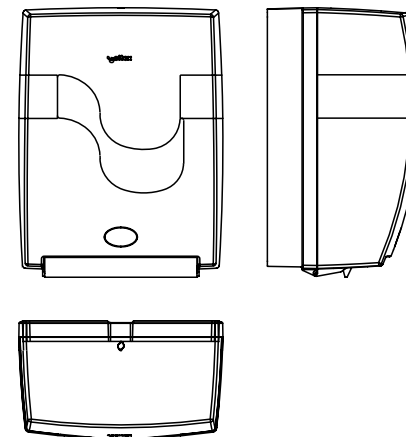

Materiale: plastica
Dimensioni: L= 300 mm P=220 mm H=410 mm
Peso netto: gr 4.200

DISPENSER AUTOCUT MEGAMINI

Autocut con sistema di erogazione meccanica totalmente nuovo.

DISPENSER AUTOCUT ROTOLI ASCIUGAMANI



Cod. 92600
Colore: Nero



Cod. 92620
Colore: Bianco

DISPENSER AUTOCUT SYSTEM



Cod. 92610
Colore: Nero



Cod. 92630
Colore: Bianco

Scheda Tecnica

Dim. imballo:
L= 400 mm P= 260 mm H= 365 mm
Tipo imballo: scatola cartone
Peso Lordo: gr 3150
Pezzi per collo: 1
Volume imballo: 38,0 dm³
Colli per pallet: 54

- Sistema di erogazione manuale altamente igienico: si tocca solo la carta che si usa.
- Minore resistenza nella trazione: facile erogazione del prodotto.
- Minore rumorosità durante l'utilizzo.
- Nuovo design della manopola di riarmo: consente il massimo comfort e la totale ergonomia.
- La finestra semi trasparente rende facile vedere quando bisogna ricaricare il dispenser.
- Dimensione dello strappo: 28 cm.
- Per rotoli asciugamani H. max cm 22, diam. max cm 20.
- Indicato per tutti i tipi di carta (1, 2, 3 veli).

Articoli Associati

- 40439
- 40437
- 40442
- 40300
- 40106
- 40107
- 40510

Articoli Associati

- 41995
- 41913
- 41922

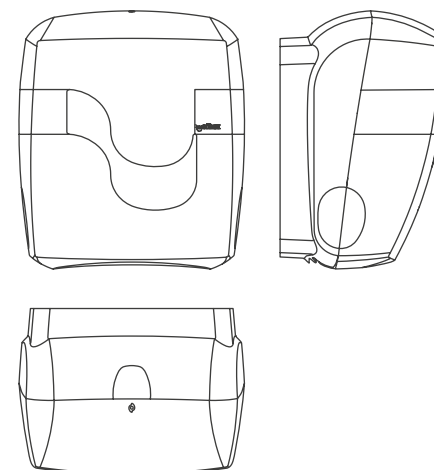

Materiale: plastica
Dimensioni: L= 330 mm P=250 mm H=390 mm
Peso netto: gr 2600

DISPENSER SAPONE



Cod. 92500
Colore: Nero



Cod. 93500
Colore: Chrome



Cod. 92520
Colore: Bianco

Scheda Tecnica

Dim. imballo:
L= 130 mm P= 120 mm H= 260 mm
Tipo imballo: scatola cartone
Peso Lordo: gr 760
Pezzi per collo: 1
Volume imballo: 4,1 dm³
Colli per pallet: 216

Articoli Associati

- 88090

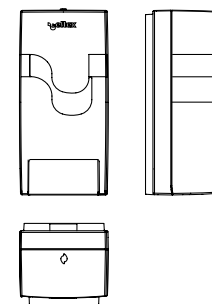

Materiale: plastica
Dimensioni: L= 118 mm P=113 mm H=250 mm
Peso netto: gr 660

HY FOAM Cartuccia semirigida sapone in mousse



Cod. 88090

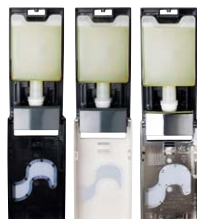

Scheda Tecnica

Dim. imballo:
L= 225 mm P= 195 mm H= 250 mm
Tipo imballo: scatola cartone
Peso Lordo: gr 4320
Pezzi per collo: 4
Volume imballo: 11 dm³
Colli per pallet: 100
Peso netto: gr 3.950

Articoli Associati

- 92500
- 92520
- 93500



CESTINO GETTACARTA



Cod. 91700
Colore: Nero



Cod. 91720
Colore: Bianco

Materiale: plastica
Dimensioni: L= 330 mm P=220 mm H=580 mm
Peso netto: gr 3.850
Capacità 23 lt

Scheda Tecnica

Dim. imballo:
L= 340 mm P= 230 mm H= 610 mm
Tipo imballo: scatola cartone
Peso Lordo: gr 4500
Pezzi per collo: 2
Volume imballo: 47,7 dm³
Colli per pallet: 38



CELTEX

Loc. il Teso,
Via Traversa del Marginone 21/23
55015 Montecarlo
Lucca - Italy

P. +39 0583 27 41
F. +39 0583 277 777

Info@celtex.it